

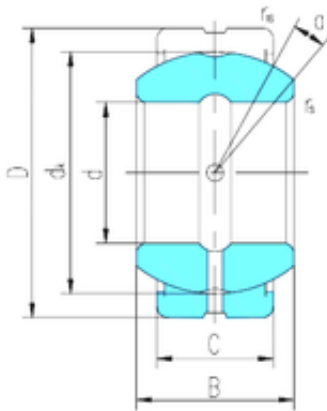

BEARING CORP. LTD.

50 mm x 75 mm x 35 mm LS GE50ES-2RS plain bearings



Bearing No. GE50ES-2RS

Size	50x75x35 mm
Bore Diameter	50 mm
Outer Diameter	75 mm
Width	35 mm
d	50 mm
D	75 mm
B	35 mm
C	28 mm
dk	66 mm
r min.	0,6 mm
r1 min.	1 mm
Angle	6 °
Weight	0,562 Kg
Basic dynamic load rating (C)	156 kN

GE50ES-2RS Bearing 2D drawings and 3D CAD models